

**ClimaPlus / ClimaPlus**

Spannung / Voltage: **3 N AC 400V 50Hz**

Baugruppe / Group: **3** Ausgabe / Edition: **3.1.1**

Gültig ab Seriennummer / Applicable from serial. no.: **E11CA97061001**

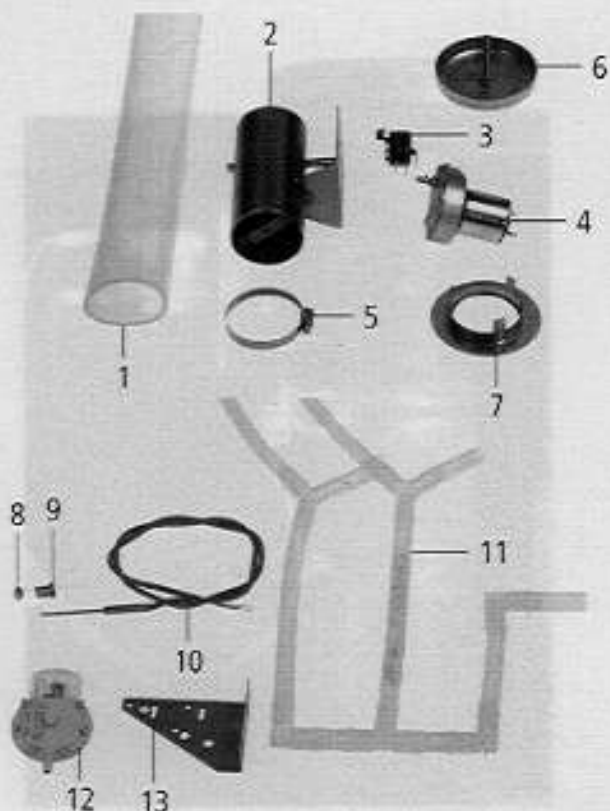
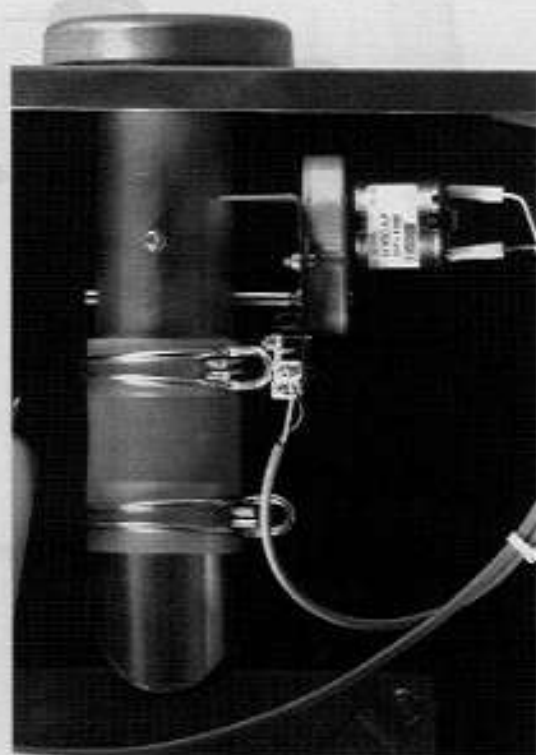

Pos.	St.	Ersatzteil Nr.	Bezeichnung	Description	Bez. Sign.
Pos.	Pcs.	Spare part no.			
-	1	8450.1300	Belüftungsklappe kpl	Humidity control cpl	
1	1	2112.1301	Silikonschlauch d50x3x100	Silicone hose d50x3x100	
2	1	8720.1306	Belüftungseinheit	Humidity control assy	
3	1	3016.0101	Mikroschalter	Micro switch humidity control	S4
4	1	3101.1010	Belüftungsstellmotor 12V	Humidity control motor 12V	M3
5	2	2066.0504	Schlauchschelle 40-60mm	Hose clamp 40-60mm	
6	1	8455.1209	Glocke Typ 61/101	Vent cover 61/101	
7	1	2812.1304	Abstandshalter für Glocke	Spacer for vent cover	
8	1	3014.0162	Dichtkegel für Thermoelement	Sealing cone for thermo element	
9	1	3014.0163	Stopfbuchsnippel für Thermoelement	Gasket sleeve with nipple	
10	1	3014.1003	Thermoelement kurz	Thermocouple short	B4
11	1	8680.1301	Syphon Feuchtsteuerung	Humidity control syphon	
12	1	3017.1002	Drucksensor für Feuchtigkeitsmessung	Pressure sensor for humidity control	P1
13	1	2760.1120	Haltewinkel für Drucksensor	Holding bracket for pressure sensor	

**Bedienblende / Control panel**

 Spannung / Voltage: **3 N AC 400V 50Hz**

 Baugruppe / Group: **1** Ausgabe / Edition: **1.1.1**

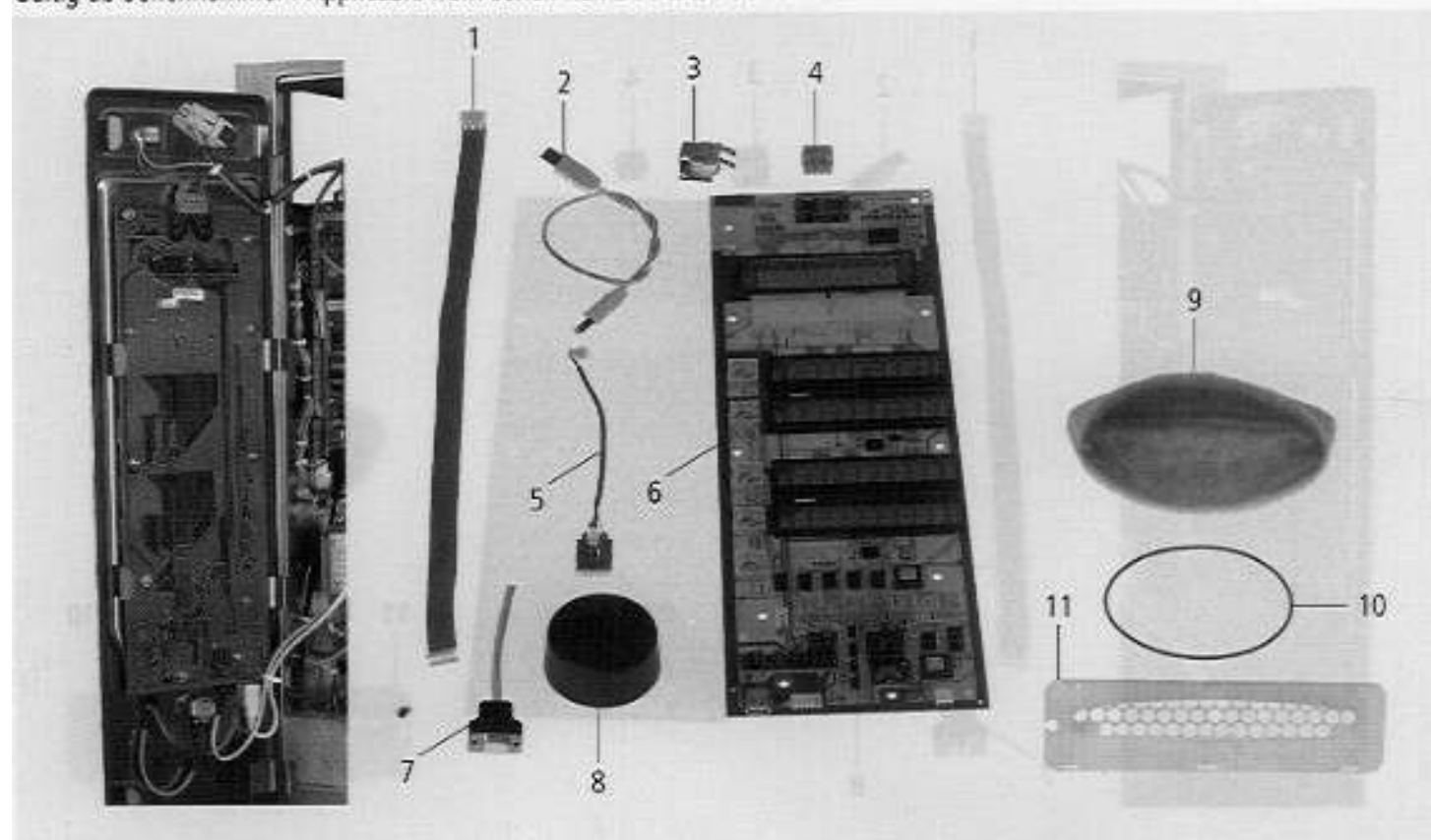
 Gültig ab Seriennummer / Applicable from serial. no.: **E11CA97061001**

Pos.	St.	Ersatzteil Nr.	Bezeichnung	Description	Bez.
Pos.	Pcs.	Spare part no.			Sign.
1	1	8720.1300	Datentransferkabel CPU-Bedienplatine	Bus cable CPU - operator pcb	
2	1	8720.1302	Kabel für Spannungsversorgung	Power supply cable operator pcb	
3	1	3006.0107	Alarmsummer 12V, AC	Buzzer 12V ac	T2
4	1	3040.0255	Steckerleiste 4pol, 5.08	Multipoint connector 4pol, 5.08	
5	1	8817.1303	Impulsgeber kpl.	Pulse generator cpl.	S6
6	1	3040.3020	Bedienplatine	Operator pcb	A1
7	1	8817.1040	Schnittstellenkabel	Interface cable	
8	1	3013.0355	Knebel für Impulsgeber	Dial for pulse generator	
9	1	5214.1300	Luftfilter Bedienblende	Air inlet filter control panel	
10	1	5012.0565	O-Ring d 115x2,5mm	O-ring d 115x2,5mm	
11	1	2039.0337	Filterträger Bedienblende	Filter support control panel	
-	1	5100.1011	Dichtung für Blendeneinsatz	Gasket frame for panel	

**Gerätetür / Door**

 Spannung / Voltage: **3 N AC 400V 50Hz**

 Baugruppe / Group: **8** Ausgabe / Edition: **8.1.1**

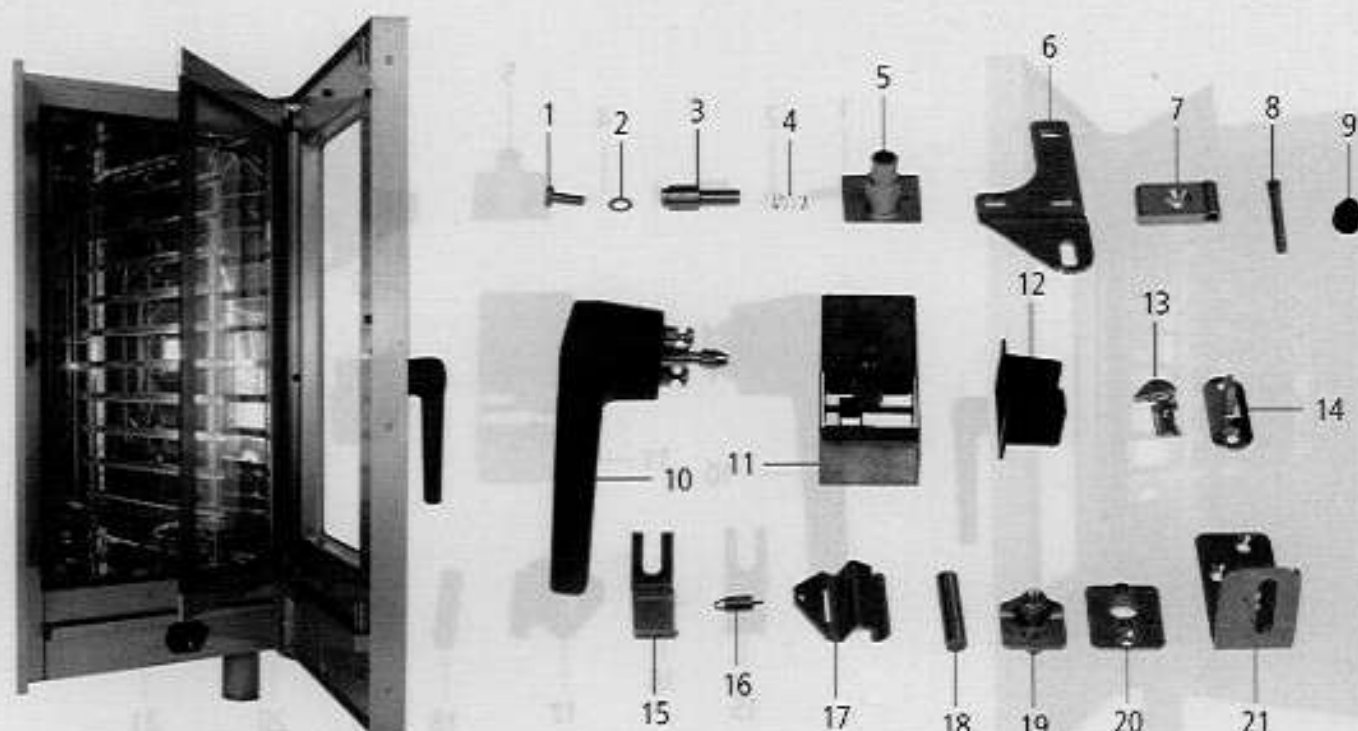
 Gültig ab Seriennummer / Applicable from serial. no.: **E11CA97061001**

Pos.	St.	Ersatzteil Nr.	Bezeichnung	Description	Bez.
Pos.	Pcs.	Spare part no.			Sign.
-	1	8470.1301	Türe kpl.	Door cpl.	
-	1	8474.1337	Innenglassscheibe kpl.	Internal glass cpl.	
-	1	5105.1021	Garraumdichtung	Door gasket	
1	1	1006.0761	Sechskantschraube M 6x12	Hexagonal screw M 6x12	
2	1	1306.0120	Unterlegscheibe A6,4	Washer A6.4	
3	1	2120.1254	Achszapfen Tür oben	Door bolt top	
4	1	2001.0118	Druckfeder oberer Türhaltebolzen	Compression spring upper door bolt	
5	1	2940.1300	Achshülse Tür oben	Sleeve for door bolt top	
6	1	2939.1307	Türhaltewinkel oben	Door holding angle top	
-	3	1008.0200	Linsenkopfschraube mit Innensechskant	Raised countersunk allen screw M8x16	
7	1	2940.1309	Scharnier für Innenscheibe	Hinge for inner glass	
-	2	1005.1960	Senkschraube mit Innensechskant M5x16	Hex socket countersunk head screw M5x16	
8	1	2120.1258	Rändelbolzen für Türhaltescharnier	Knurdeled bolt for inner door hinge	
9	1	2039.0402	Puffer für Türe	Door buffer	
10	1	2016.1504	Türgriff	Door handle	
11	1	8474.1300	Verschluss kpl. für Tür	Lock for door handle cpl.	
12	1	2039.0319	Abdeckung f. Schloß Innenseite	Internal lock cover	
13	1	2940.1312	Kloben für Türe	Door catch	
-	1	1005.2000	Sperrzahnschraube M 5x8	Interlocking tooth screw M 5x8	
14	1	2940.1313	Klobenhalter für Türe	Base for door catch	
-	2	1006.0761	Sechskantschraube M 6x12	Hexagonal screw M 6x12	
15	1	2760.1396	Federhalter für Arretierung Innenglassscheibe	Spring support for interior glass holding bracket	
16	1	2002.0106	Zugfeder für Arretierung Innenglassscheibe	Tension spring for inner window	
17	1	2760.1395	Arretierung Innenglassscheibe	Holding bracket for interior glass	
18	1	3016.1409	Magnet rund Tischgeräte	Magnet round table models	
19	1	2940.1302	Rasthülse	Door setting bolt	
-	1	1008.0766	Sechskantschraube M8x30	Hexagonal screw M8x30	
20	1	2940.1303	Rastzapfen 110°	Stop bolt 110°	
-	1	1005.1960	Senkschraube mit Innensechskant M5x16	Hex socket countersunk head screw M5x16	
21	1	2930.1306	Türhaltewinkel unten	Door mounting support bottom	
-	3	1006.1960	Senkschraube mit Innensechskant M6x16	Hexagonal socket countersunk head screw M6x16	



**Elektromontageplatte / Electrical Installation**

Spannung / Voltage: **3 N AC 400V 50Hz**

Baugruppe / Group: **2** Ausgabe / Edition: **2.2.1**

Gültig ab Seriennummer / Applicable from serial. no.: **E11CA97061001**

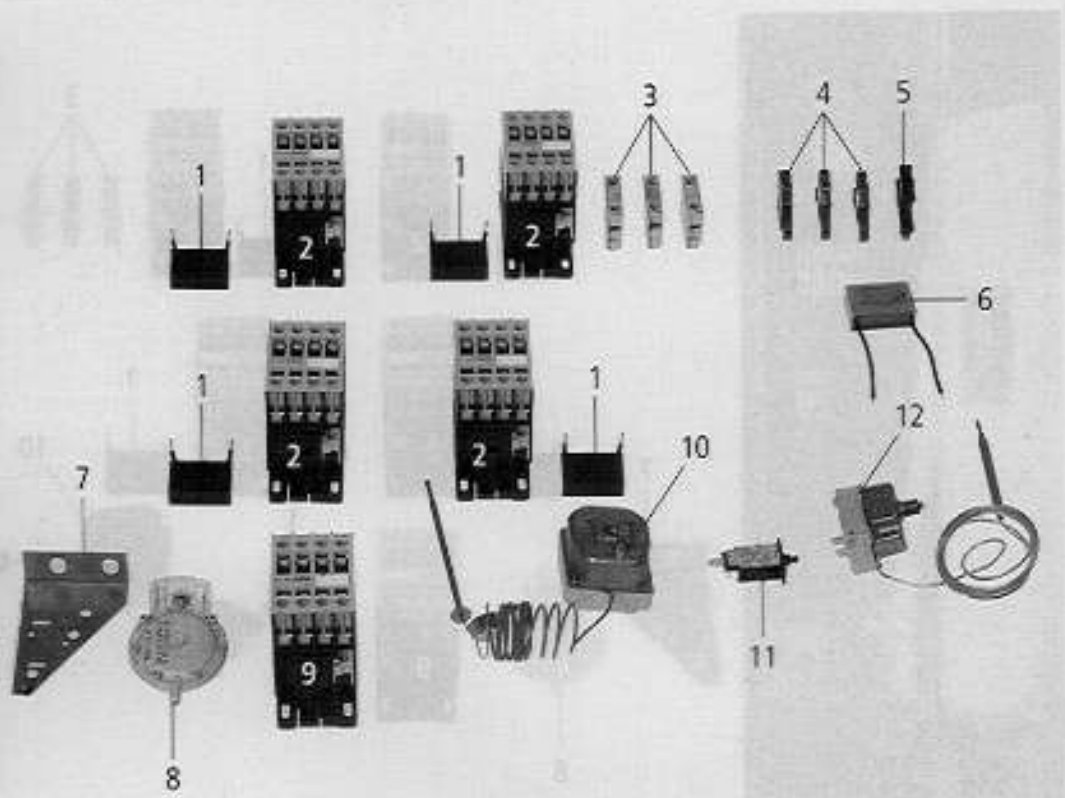

Pos.	St.	Ersatzteil Nr.	Bezeichnung	Description	Bez. Sign.
Pos.	Pcs.	Spare part no.			
1	4	3028.0562	RC-Glied für LS4K - LS30K	RC-link for LS4K - LS30K	C2-C5
2	4	3028.0550	Schütz AEG LS 4K01	Contacteur AEG LS 4K01	K2
3	3	3028.0560	Hilfskontaktschalter HS07K10 N/C	Auxiliary contact switch HS07K10 N/C	
4	3	4001.1216	Reihenklemme 4mm <sup>2</sup> grau	Terminal 4mm <sup>2</sup> grey	
5	1	4001.1203	Endklammer für Tragschiene	End plate for supporting rail	
6	1	3102.1000	Wechselspannungskondensator 1,5 µF,250V	Capacitor 1,5 µF,250V AC	C1
7	1	2760.1120	Haltewinkel für Drucksensor	Holding bracket for pressure sensor	
8	1	3017.1002	Drucksensor für Feuchtigkeitsmessung	Pressure sensor for humidity control	P1
9	1	3028.0552	Schütz AEG LS 7K10	Contacteur AEG LS7K10	K1
10	1	3014.0326	Sicherheitstemperaturbegrenzer 360°C	Safety temperature limiter 360°C	F3
11	1	3014.0402	Überstromauslöser einpolig f. Motorschutz	Current limiter for motor protection	F5
12	1	3014.0300	Trockengehschutz 135°C	Dry up protector 135°C	F2

**Elektromontageplatte / Electrical Installation**

Spannung / Voltage: **3 N AC 400V 50Hz**

Baugruppe / Group: **2** Ausgabe / Edition: **2.3.1**

Gültig ab Seriennummer / Applicable from serial. no.: **E11CA97061001**

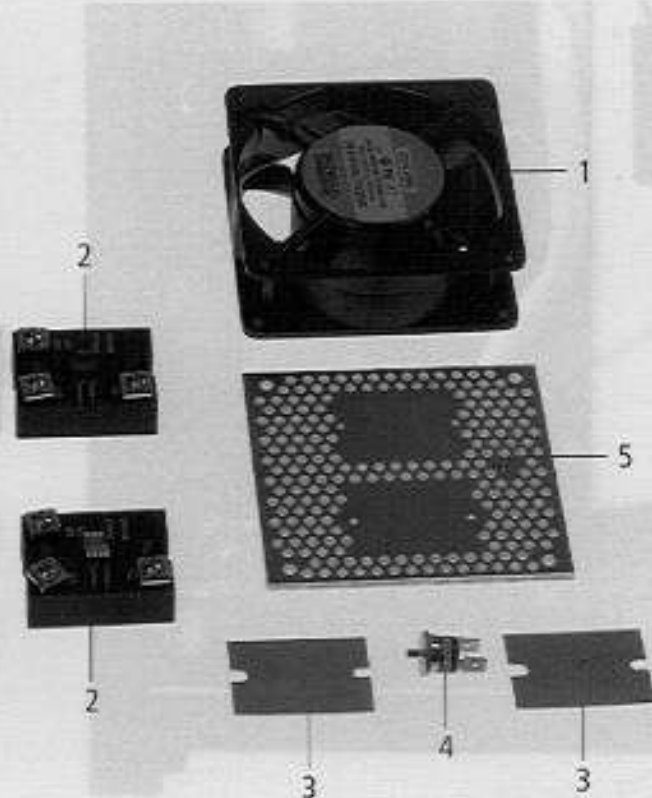
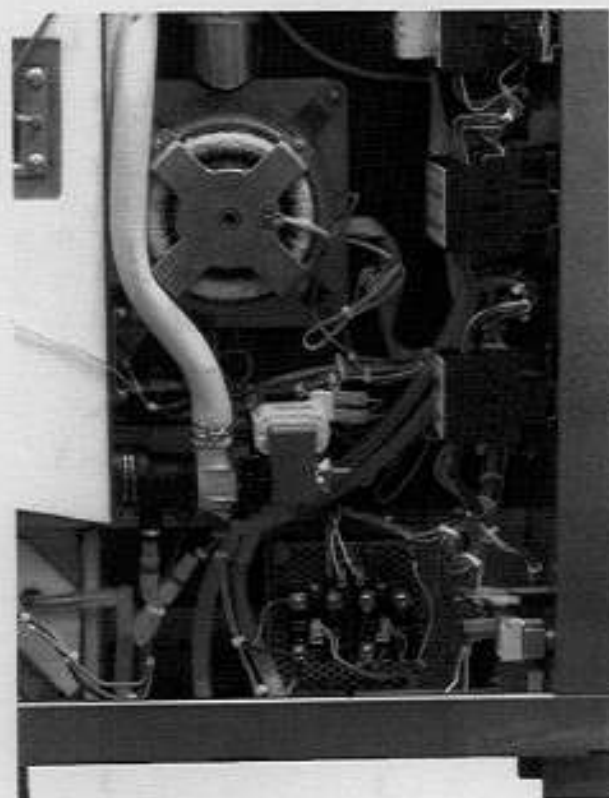

Pos.	St.	Ersatzteil Nr.	Bezeichnung	Description	Bez.
Pos.	Pcs.	Spare part no.			Sign.
1	1	3101.1008	Kühlflüster	Cooling motor	M2
2	2	3028.0533	Leistungshalbleiter 2x40A	Solid State relais 2pol, 40A	K3,3.1
-	4	1004.0500	Gewinde Schneidschraube M4x8 mit Linsenkopf	Raised countersunk metal screw M4x8	
-	4	1204.0120	Zahnscheibe A4,3	Toothed lock washer A4,3	
3	2	3028.0531	Wärmeleitfolie für Leistungshalbleiter	Heat transfer tape solid state relais	
4	1	3014.0325	Bimetallschalter 110°, Halbleiterplatte	Bimetal switch 110° solid state relay	F4
5	1	2930.1302	Kühlplatte-Leistungshalbleiter	Cooling plate solid state relay	
-	4	1004.0662	Innensechskantschraube M4x25	Allen screw M4x25	
-	4	1204.0120	Zahnscheibe A4,3	Toothed lock washer A4,3	
-	4	1306.0218	Unterlegscheibe A4,3 DIN9021	Washer A4,3 DIN9021	
-	4	1104.0122	Sechskant-Combimutter M4 verzinkt	Hex combination nut M4 galv	

**Elektromontageplatte / Electrical Installation**

 Spannung / Voltage: **3 N AC 400V 50Hz**

 Baugruppe / Group: **2** Ausgabe / Edition: **2.1.1**

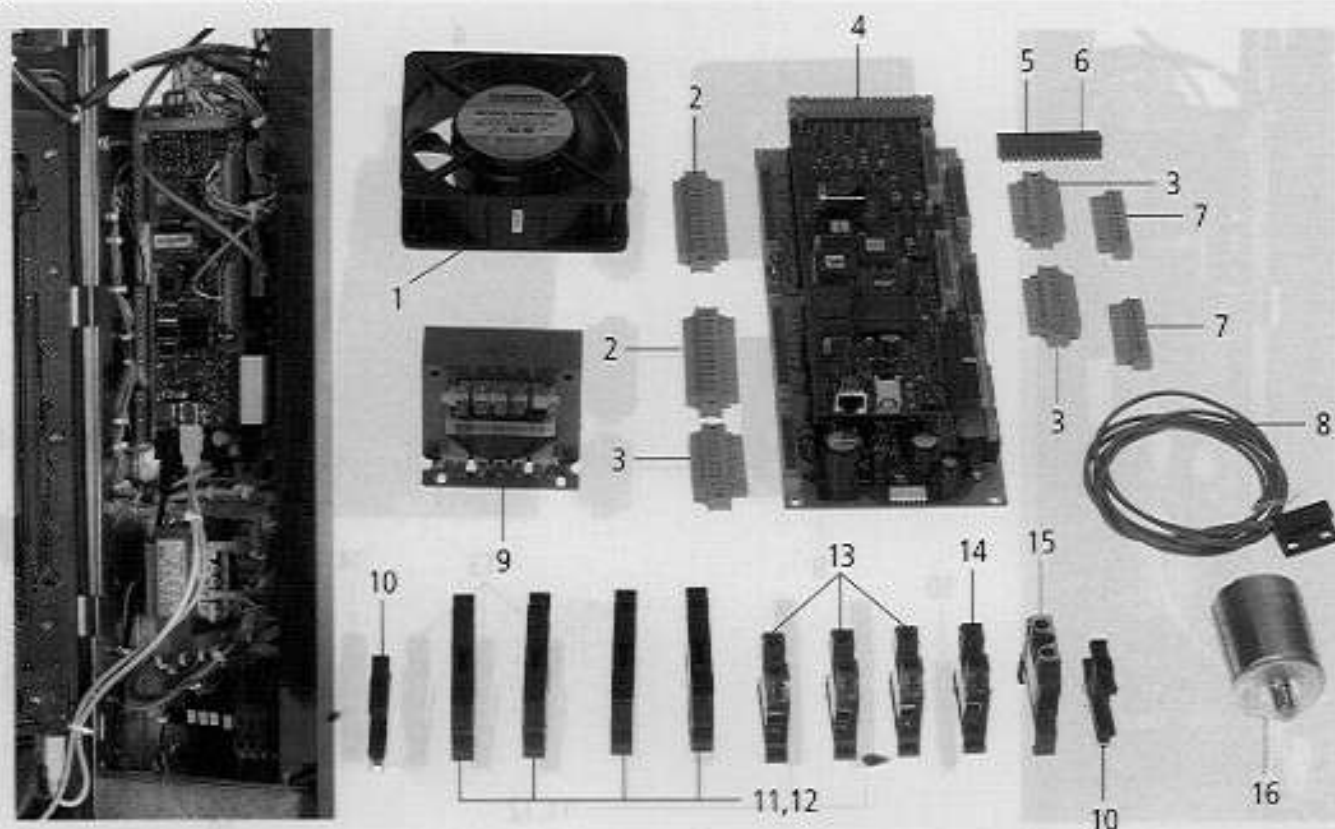
 Gültig ab Seriennummer / Applicable from serial. no.: **E11CA97061001**

Pos.	St.	Ersatzteil Nr.	Bezeichnung	Description	Bez. Sign.
Pos.	Pcs.	Spare part no.			
1	1	3101.1008	Kühllüfter	Cooling motor	M2
2	2	3040.0254	Steckerleiste 12pol, 5.08	Multipoint connector 12pol, 5.08	
3	3	3040.0253	Steckerleiste 8polig, 5.08Raster	Multipoint connector 8pol, 5.08	
4	1	3040.3000	Bedienplatine	Operator pcb	A2,A3
5	1	3040.0262	Steckerleiste links 10polig, 3.5	Multipoint connector left 10polig, 3.5	
6	1	3040.0261	Steckerleiste rechts 10polig 3.5	Multipoint connector right 10polig	
7	2	3040.0256	Steckerleiste 12pol, 3.5	Multipoint connector 12pol, 3.5	
8	1	3016.1415	Türkontaktschalter	Door contact switch	S3
9	1	3037.0240	Steuertrafo 200-260V	Control transformer 200-260V	T1
10	2	4001.1203	Endklammer für Tragschiene	End plate for supporting rail	
11	4	4001.1283	Sicherungsklemme 6x32 4 qmm	Fuse holder terminal block 4qmm,6x32mm	F1,F7
12	4	4001.0224	Sicherung 6.35x32mm, 6.3A träge	Fuse 6.35x32mm, 6.3A slow	F1,F7
13	3	4001.1202	Reihen клемme 16mm <sup>2</sup> grau	Terminal 16mm <sup>2</sup> grey	
14	1	4001.1250	Reihen клемme 16mm <sup>2</sup> blau	Terminal 16mm <sup>2</sup> blue	
15	1	4001.1210	Erdungsreihen клемme 16mm <sup>2</sup> gelb/grün	Earth terminal 16mm <sup>2</sup> yellow/green	
16	1	3001.0455	Entstörfilter	Electronic noise filter	Z1



**Handbrause / Hand shower**

Spannung / Voltage: **3 N AC 400V 50Hz**

Baugruppe / Group: **10** Ausgabe / Edition: **10.1.1**

Gültig ab Seriennummer / Applicable from serial. no.: **E11CA97061001**

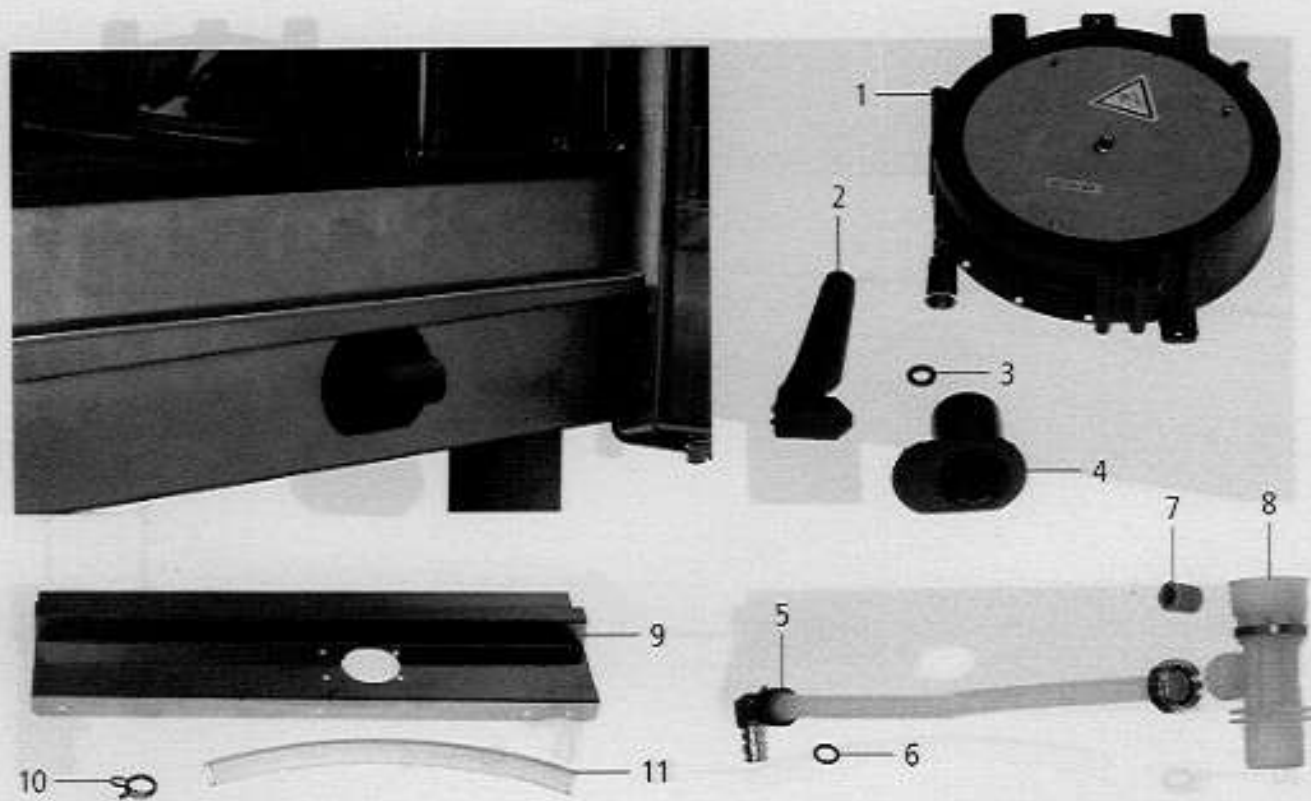

Pos.	St.	Ersatzteil Nr.	Bezeichnung	Description	Bez.
Pos.	Pcs.	Spare part no.			Sign.
1	1	8655.2021	Schlauchroller	Handshower roll guide	
2	1	2060.1000	Handbrause	Hand shower	
3	1	5012.0539	Dichtung für Verschraubung G 1/2"	Gasket for G1/2" threaded joint	
4	1	2060.1210	Tulpe für Handbrause	Tulip for handshower	
-	4	1107.0103	Schnellbefestiger d3mm	Quick fastener d3mm	
5	1	2062.0327	Anschlußrohr Schlauchroller	Connecting pipe hand shower	
6	2	2060.0228	O-Ring für Brauseschlauch	O-ring for shower hose	
7	1	2069.0105	Rückschlagventil DN8	Non return valve DN8	
8	1	8464.1300	T-Stück Wasseranschluss Handbrause	T-water connection handshower	
9	1	8455.1315	Gerätetropfwanne	Drip collector	
10	1	2066.0525	Schlauchklemme 22,1mm	Hose clamp 22,1mm	
11	1	2110.1002	Silikonschlauch d15x3	Silicone hose d15x3	

**Heißluftheizung / Hot air heating**

Spannung / Voltage: **3 N AC 400V 50Hz**

Baugruppe / Group: **5** Ausgabe / Edition: **5.1.1**

Gültig ab Seriennummer / Applicable from serial. no.: **E11CA97061001**

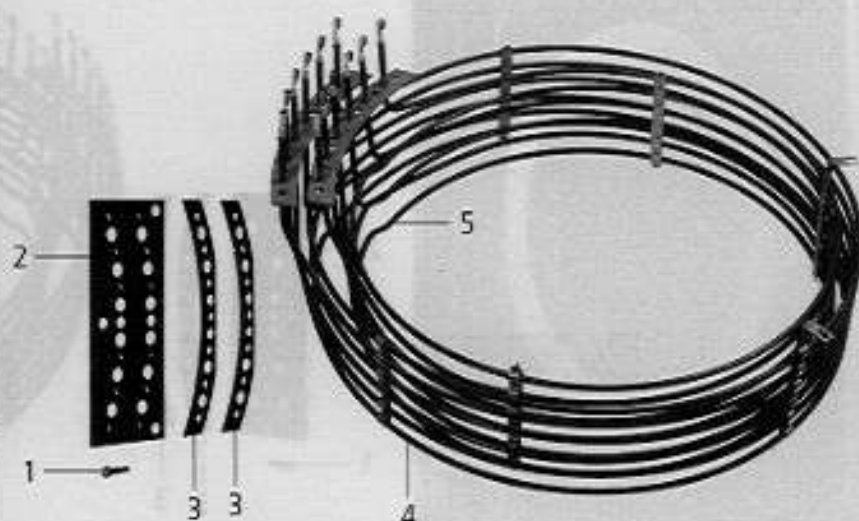
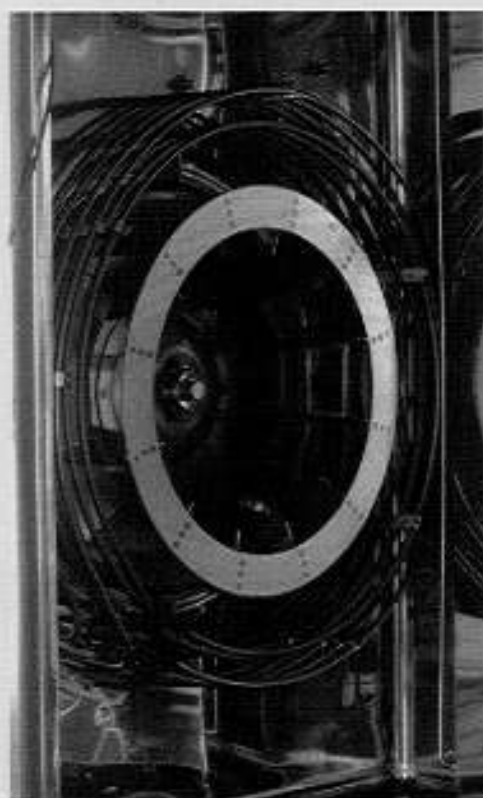

Pos.	St.	Ersatzteil Nr.	Bezeichnung	Description	Bez. Sign.
Pos.	Pcs.	Spare part no.			
1	12	1006.0766	Sechskantschraube M 6x25, HL Register	Hex screw M6x25, hot air heater	
-	14	1306.0222	Unterlegscheibe A6,4	Washer A6,4	
2	1	2150.1251	Doppelflansch Aussenseite	External double flange for hot air heater	
3	2	5110.1009	Dichtring f. Heizregister	Seal ring for heating assembly	
4	1	3200.1001	Heizregister außen 230V	Outer heating assembly 230V	
5	1	3200.1000	Heizregister innen 230V	Inner heating assembly 230V	
-	2	1106.0360	Hutmutter M6 hohe Form	Cap nut M6, high shape	



**Garraum / Interior cabinet**

Spannung / Voltage: **3 N AC 400V 50Hz**

Baugruppe / Group: **7** Ausgabe / Edition: **7.1.1**

Gültig ab Seriennummer / Applicable from serial. no.: **E11CA97061001**

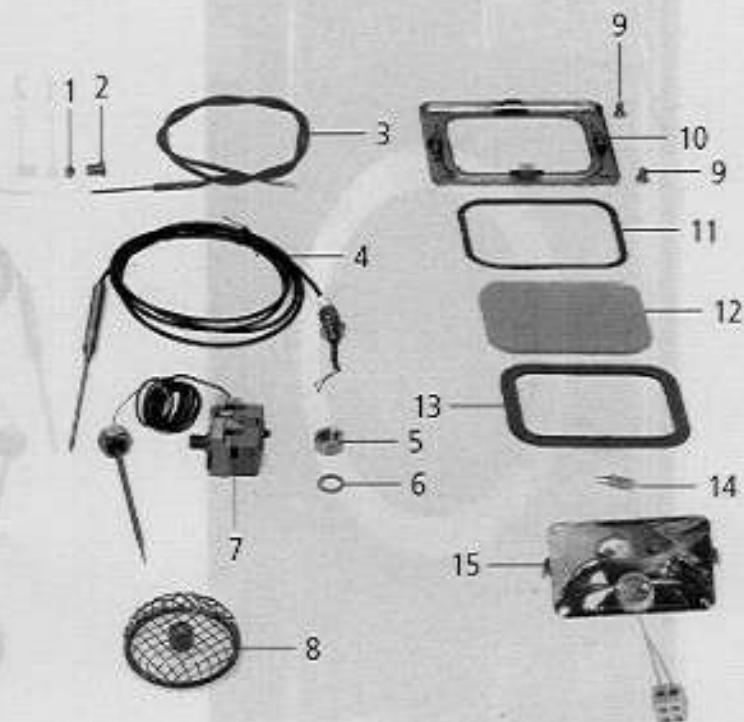
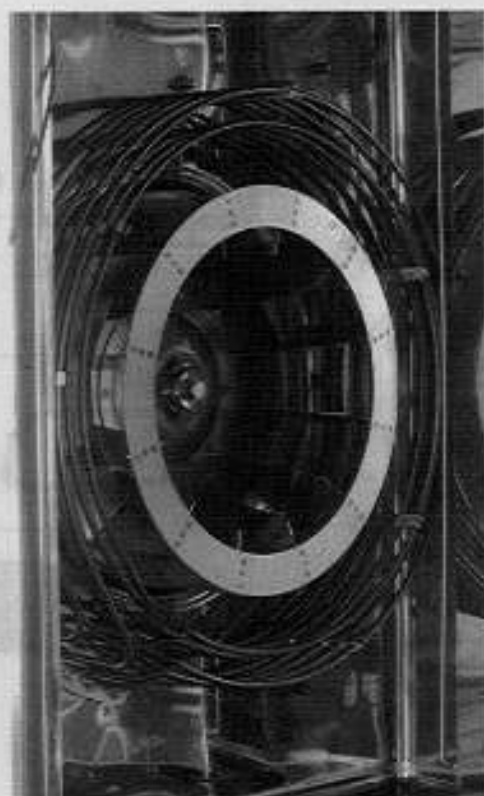

Pos.	St.	Ersatzteil Nr.	Bezeichnung	Description	Bez. / Sign.
Pos.	Pcs.	Spare part no.			
-	1	8516.1301	Luftleitblech	Air baffle	
1	1	3014.0162	Dichtkegel für Thermoelement	Sealing cone for thermo element	
2	1	3014.0163	Stopfbuchsnippel für Thermoelement	Gasket sleeve with nipple	
3	1	3014.1000	Thermoelement - lang -	Thermocouple -long-	B1
4	1	3035.0710	Einstechfühler	Meat probe sensor	B3
5	1	1112.0110	Sechskantmutter M 10	Hexagonal nut M10	
6	1	1315.0105	Kupferdichtung für Einstechfühler	Copper washer for meat probe sensor	
7	1	3014.0326	Sicherheitstemperaturbegrenzer 360°C	Safety temperature limiter 360°C	F3
8	1	2005.0302	Ablaufsieb	Outlet sieve	
9	4	1008.0753	Sechskantschraube M 5x8	Hexagonal screw M5x8	
10	1	8514.1017	Andrückrahmen f. Garraumbeleuchtung	Press down frame for interior lighting	
11	1	5110.1022	Dichtungsrahmen außen	External gasket frame	
12	1	5201.1000	Glas f. Garraumbeleuchtung	Glass for interior lamp	
13	1	5110.1023	Dichtungsrahmen innen	Internal gasket frame	
14	1	3024.0201	Halogengarraumlampe 10 W/12V/300°	Halogen bulb 10 W/12V/300°	H1
15	1	8514.1018	Reflektor kpl. f. Garraumbeleuchtung	Reflector unit for interior lighting	

**Motor und Lüfterrad / Motor and fan wheel**

Spannung / Voltage: **3 N AC 400V 50Hz**

Baugruppe / Group: **6** Ausgabe / Edition: **6.1.1**

Gültig ab Seriennummer / Applicable from serial. no.: **E11CA97061001**

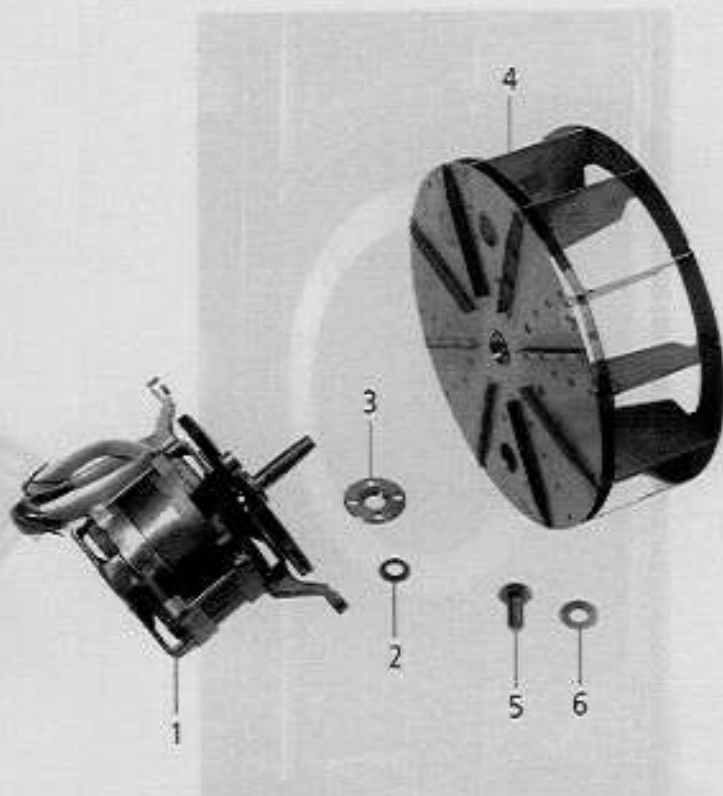
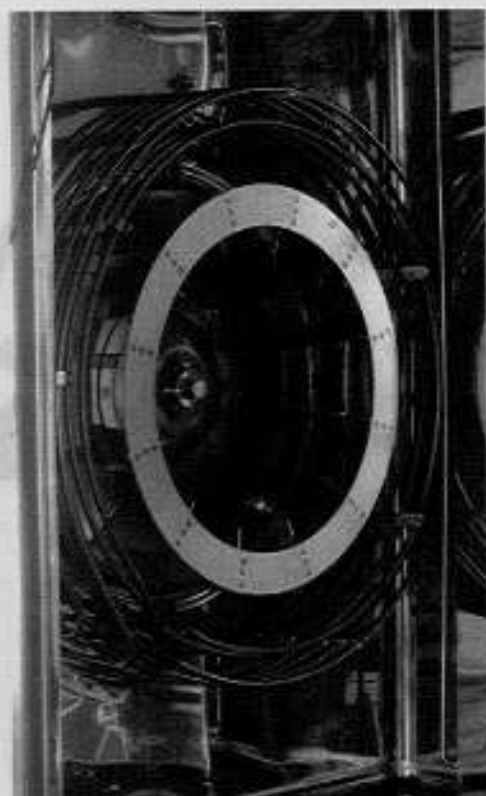

Pos.	St.	Ersatzteil Nr.	Bezeichnung	Description	Bez. Sign.
Pos.	Pcs.	Spare part no.			
1	1	3100.1020	Lüftermotor 4/8pol	Fan motor 4/8pol	MT
-	4	1108.0260	Sechskantmutter M 8	Hexagonal nut M8	
-	4	1208.0260	Federring B8	Spring washer B8	
2	1	5001.0207	Motorwellendichtung	Motor shaft gasket type	
3	1	2016.0876	Dichtungsflansch für Motorwelle	Gasket flange for engine shaft	
-	4	1106.0220	Sechskantmutter M6 flach	Hexagonal nut M6 flat	
-	4	1306.0120	Unterlegscheibe A6,4	Washer A6.4	
4	1	2012.0507	Lüfterrad	Fan wheel	
5	1	1010.0762	Sechskantschraube M 10x20	Hexagonal screw M10x20	
6	1	1328.0102	Sperrkantscheibe A10,2	Safety washer A10,2	

**Dampfgenerator / Steam generator**

 Spannung / Voltage: **3 N AC 400V 50Hz**

 Baugruppe / Group: **4** Ausgabe / Edition: **4.1.1**

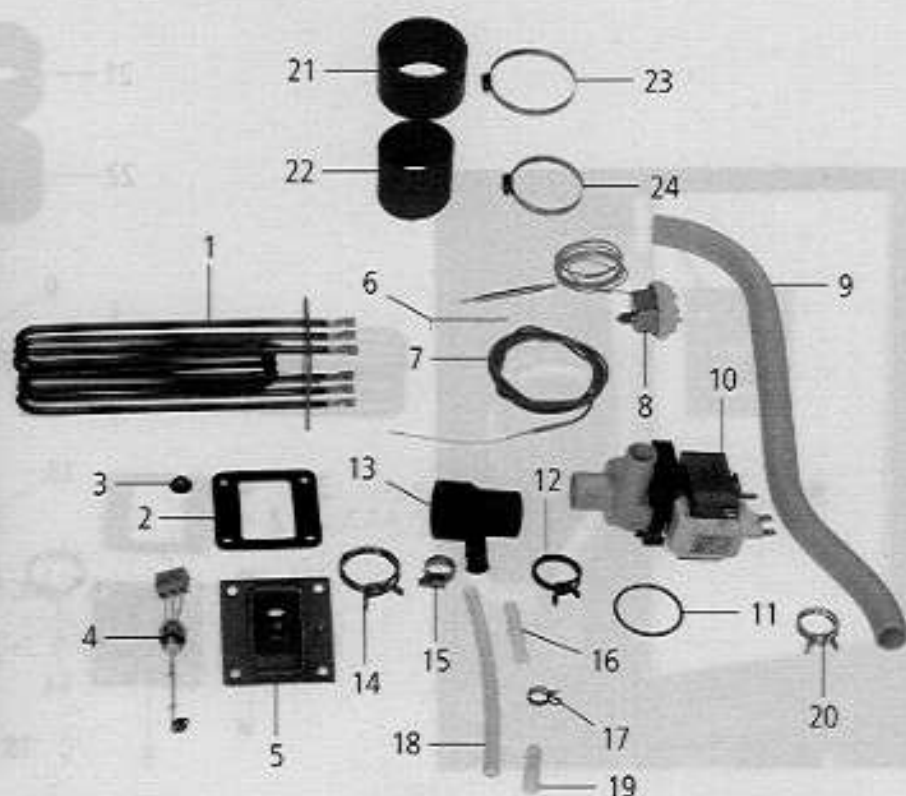
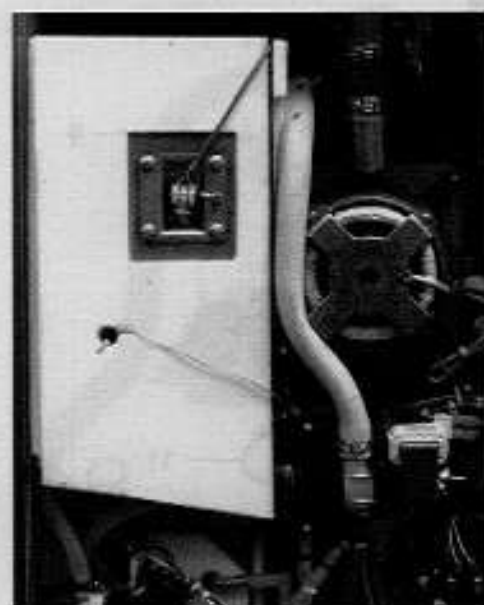
 Gültig ab Seriennummer / Applicable from serial. no.: **E11CA97061001**

Pos.	St.	Ersatzteil Nr.	Bezeichnung	Description	Bez. Sign.
Pos.	Pcs.	Spare part no.			
-	-	2067.0050	Silikonschlauch 1m	Silicone hose 1m	
1	2	3201.1000	Tauchheizkörper 3x3 kw 230V	Heating element 3x3 kw 230V	
2	3	5110.1003	Dichtung f. Tauchheizkörper	Gasket for heating element	
3	12	1106.0803	Sechskant-Combimutter M6 verzinkt	Hex combi nut M6 galv	
4	1	3002.0402	Füllstandselektrode 90mm	Filling level electrode 90mm	S2
5	1	2920.1300	Einsatz Niveauelektrode	Level elektrode insert	
6	1	2740.1040	Klemmblech Dampfgenerator	Clamping plate for steam generator	
7	1	3014.0165	Thermoelement Dampfgenerator	Thermo element steam generator	B5
8	1	3014.0300	Trockengehschutz 135°C	Dry up protector 135°C	F2
9	1	2112.1303	Entleerschlauch	Emptying hose	
10	1	3002.1000	Entleerungspumpe 200-240V 50/60Hz	Emptying pump 200-240V 50/60Hz	M4
11	1	5012.0560	O-Ring Dichtung Entleerungspumpe	O-Ring gasket emptying pump	
12	1	2066.0519	Schlauchklemme 35,6mm	Hose clamp 35,6mm	
13	1	2118.1000	Pumpenanschlußstutzen	Pump connection spout	
14	1	2066.0526	Schlauchklemme 46mm	Hose clamp 46mm	
15	1	2066.0530	Schlauchklemme 16,4mm	Hose clamp 16,4mm	
16	1	2062.0331	Verbindungsteil GS 10	Connecting piece GS 10	
17	1	2066.0527	Schlauchklemme 14mm	Hose clamp 14mm	
18	1	2110.1008	Silikonschlauch DG-Entleerung	Drain hose steam generator	
19	1	2120.1259	Stopfen 10mm Entleerschlauch DG	Stop plug 10mm drain hose steam generat.	
20	2	2066.0518	Schlauchklemme 30mm	Hose clamp 30mm	
21	1	2112.1306	Dampfschlauch	Steam hose	
22	1	2112.1006	Dampfschlauch 50x7mm	Steam hose 50x7mm	
23	2	2066.0504	Schlauchschele 40-60mm	Hose clamp 40-60mm	
24	2	2066.0300	Schlauchschele 50-70mm	Hose clamp 50-70mm	



**Wasseranschluß / Water supply**

Spannung / Voltage: **3 N AC 400V 50Hz**

Baugruppe / Group: **9** Ausgabe / Edition: **9.1.1**

Gültig ab Seriennummer / Applicable from serial. no.: **E11CA97061001**

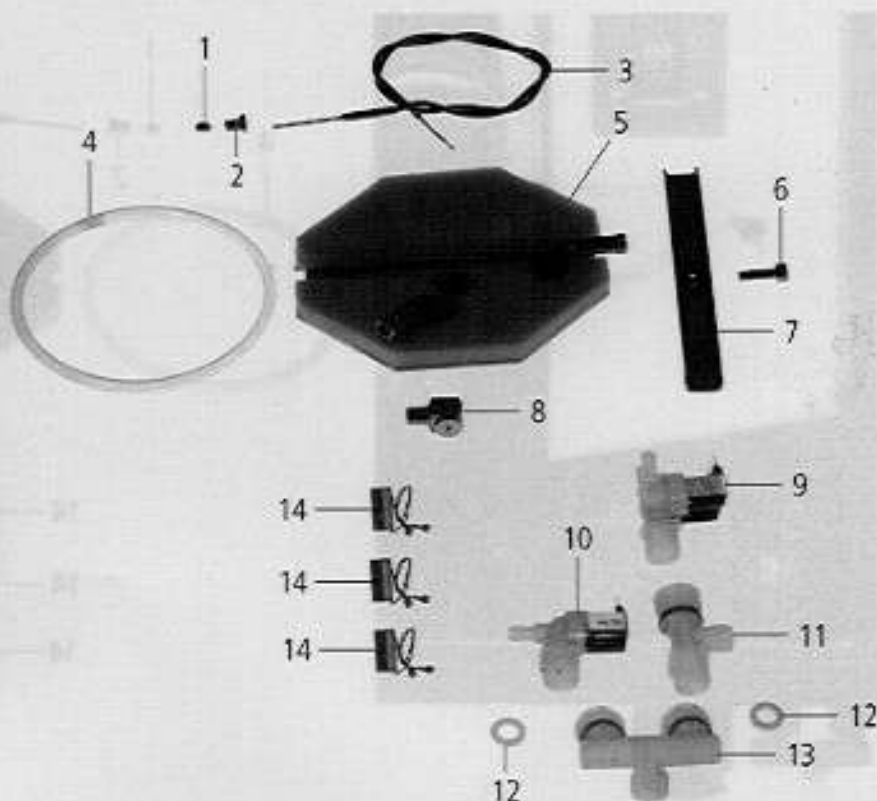
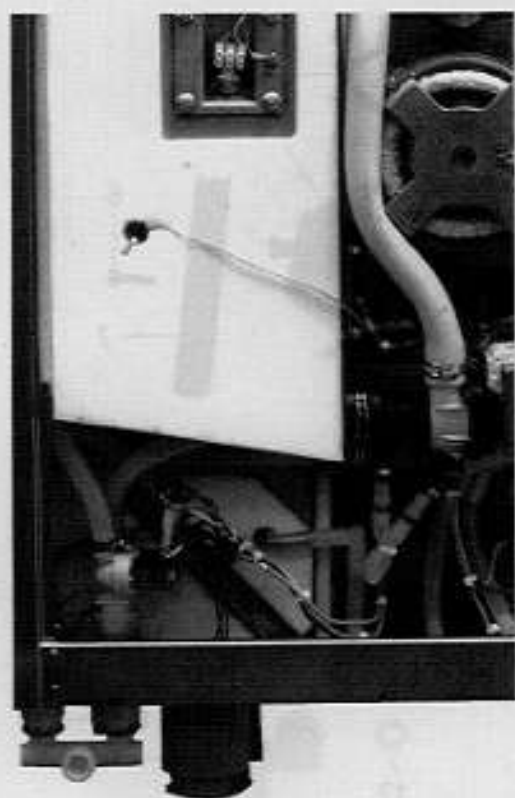

Pos.	St.	Ersatzteil Nr.	Bezeichnung	Description	Bez. Sign.
Pos.	Pcs.	Spare part no.			
-	-	2067.0050	Silikonschlauch 1m	Silicone hose 1m	
-	6	2066.0205	Schlauchselle 12-18mm	Hose clamp 12-18mm	
1	1	3014.0162	Dichtkegel für Thermoelement	Sealing cone for thermo element	
2	1	3014.0163	Stopfbuchsnippel für Thermoelement	Gasket sleeve with nipple	
3	1	3014.1005	Thermoelement kurz	Thermocouple short	B2
4	1	5012.0566	O-Ring Dichtung Ablöschkasten	O-Ring gasket quenching chamber	
5	1	8666.1318	Flansch Ablöschkasten	Flange quenching chamber	
6	1	1008.0752	Sechskantschraube M5x10	Hexagonal screw M5x10	
7	1	2715.1320	Spannbügel für Revisionsdeckel Ablöschkasten	Cross bar for cover quenching box	
8	1	2016.0935	Ablöschdüse 2,3 l/min	Quenching nozzle 2.3 l/min.	
9	1	3002.0330	Doppelmagnetventil kpl. 220-240V 50Hz	Double solenoid valve unit 220-240V 50Hz	Y1,Y3
10	1	3002.0331	Einfachmagnetventil kpl. 220-240V 50Hz	Single solenoid valve unit 220-240V 50Hz	Y2
11	1	8464.1300	T-Stück Wasseranschluss Handbrause	T-water connection handshower	
12	3	5110.1024	Dichtung für Verschraubung G 3/4"	Gasket for G3/4" threaded joint	
13	1	8664.1301	Brückenfitting 3/4" Wasseranschluss	Water connection fitting 3/4"	
14	3	3035.0508	RC-Glied	RC-link	C6-C8